

MALE END VIEW

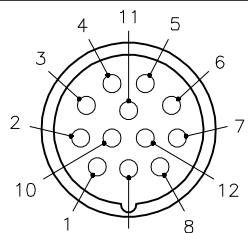

FEMALE END VIEW

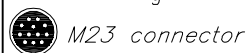
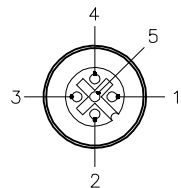

SPECIFICATIONS

HOUSING MATERIAL/COLOR	NYLON/BLACK
RECEPTACLE MATERIAL/PLATING	BRASS/NICKEL
CONTACT CARRIERS	NYLON
CONTACT CARRIER MATERIAL/PLATING	BRASS/GOLD
O-RING MATERIAL	NBR (P1), VITON (J1-J4)
OPERATING VOLTAGE	10-30 VDC
OPERATING CURRENT	2.0 AMPS/SIGNAL, 9.0 AMPS TOTAL
PROTECTION CLASS	IP67,IP69K; ONLY WHEN ALL RECEPTACLES ARE COVERED WITH PLUGS OR CONNECTED
OPERATING TEMPERATURE	-40°C to +85°C (-40°F to +185°F)

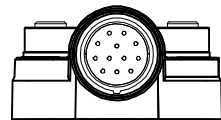
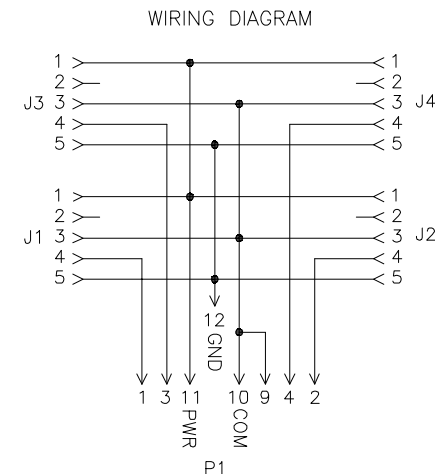
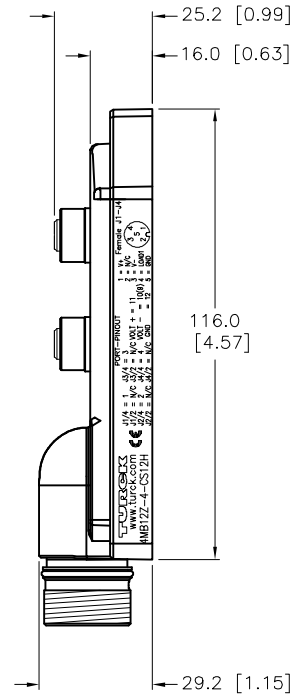
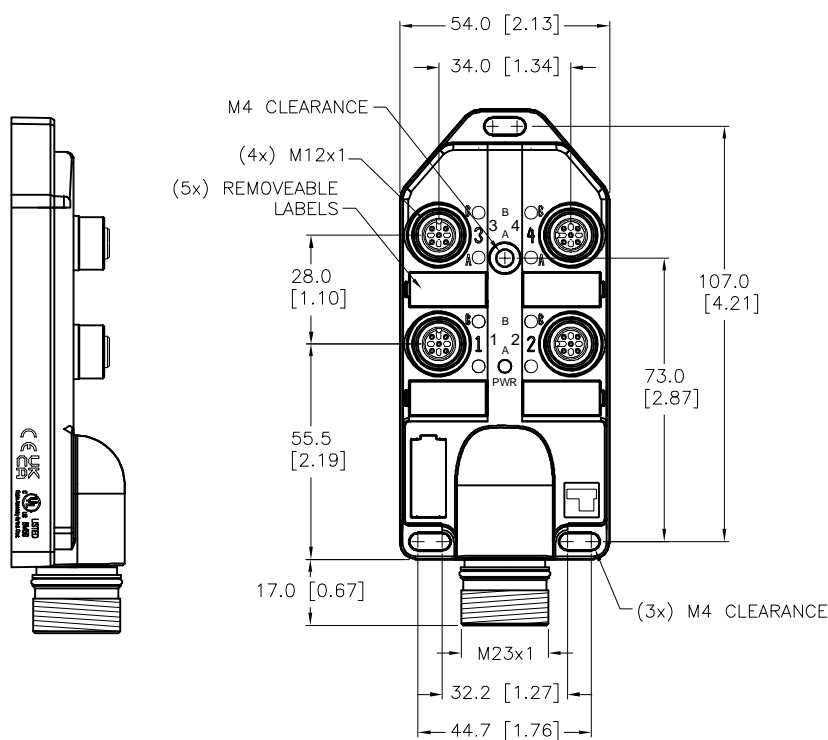

SOURCE DRAWING - FOR REFERENCE ONLY

RELATED DOCUMENTS 1. 2. 3. 4.	3RD ANGLE PROJECTION	THIS DRAWING IS CONFIDENTIAL AND THE PROPERTY OF TURCK INC. USE OF THIS DOCUMENT WITHOUT WRITTEN PERMISSION IS PROHIBITED.		3000 CAMPUS DRIVE MINNEAPOLIS, MN 55441 1-800-544-7769 (763) 553-7300 (763) 553-0708 fax www.turck.us	
	MATERIAL SEE SPECIFICATIONS	DRFT	RDS	DATE	03/06/06
		APVD		SCALE	1=2
	FINISH SEE SPECIFICATIONS	ALL DIMENSIONS DISPLAYED ON THIS DRAWING ARE FOR REFERENCE ONLY	UNIT OF MEASUREMENT MILLIMETER [INCH]		DESCRIPTION 4MB12Z-4-CS12H
CONTACT TURCK FOR MORE INFORMATION		DO NOT SCALE THIS DRAWING		IDENTIFICATION NO. E8033444	REV
I	ADD CE-UKCA MARK TO CLICHE	LV	09/09/22	500000006820	
REV	DESCRIPTION	BY	DATE	ECO NO.	FILE: E8033444